

Nomadic Communications

Renato Lo Cigno

Renato.LoCigno@dit.unitn.it - Tel: 2026

Alessandro Villani

alessandro.villani@dit.unitn.it - Tel: 3918

Dipartimento di Informatica e Telecomunicazioni

Sito del corso:

www.dit.unitn.it/locigno/didattica/NC/

What do you find on the web site

- Exam Rules
- Exam Details ... should be on ESSE3, but ...
- Generic (useful) information
- Teaching Material: normally posted at least the day before the lesson
- Additional Material and links
- News, Bulletin, How to find and meet me, etc.
- ...

The web site is work in progress and updated frequently
(that's at least my intention)

Please don't blame ME if you didn't read the last news 😊



Program

- **Why “Nomadic”**
 - Mobile vs. nomadic
 - Cellular vs. HotSpot
 - Local wireless communications
- **Some rehearsal**
 - Access Control Protocols
 - Protocols and architectures
 - Services and primitives
 - IEEE 802 project
 - Nomadic communications positioning



Program

- **WLAN**
 - 802.11 Standard
 - 802.11b MAC/PHY
 - 802.11g/a/h
 - QoS and Differentiation enhancement: 802.11e
 - Mesh networks: 802.11s
 - Other extensions: 802.11f/n/p/...
- **802.16**
 - Midway between WLAN and Cellular Networks
 - Wireless Local Loop



Program

- **Ad-Hoc Networks**
 - Stand-Alone WLANs
 - Routing and multi-hop in Ad-Hoc networks
 - Sensor and Actuator Networks
- **Personal Area Networks**
 - Bluetooth
 - 802.15 (ZigBee)
- **Mobile IP**
 - Goals and basic functions
 - Fundamentals for dynamic forwarding
 - Handovers in Mobile IP
 - Other possibilities



... Copyright

Quest'opera è protetta dalla licenza *Creative Commons NoDerivs-NonCommercial*. Per vedere una copia di questa licenza, consultare:
<http://creativecommons.org/licenses/nd-nc/1.0/>
oppure inviare una lettera a:
Creative Commons, 559 Nathan Abbott Way, Stanford, California 94305, USA.

This work is licensed under the *Creative Commons NoDerivs-NonCommercial* License. To view a copy of this license, visit:
<http://creativecommons.org/licenses/nd-nc/1.0/>
or send a letter to
Creative Commons, 559 Nathan Abbott Way, Stanford, California 94305, USA.



Why Nomadic

- Cellular Networks widely diffused
 - Expensive
 - Omnipresent
 - Still voice oriented
- The Internet *while around* requires
 - Different (faster/cheaper) network
 - Don't need to use it while *moving*
 - Want to have it "*around*" but not necessarily *everywhere*



A Fundamental Difference

Wireless Network

(sub)net where the access is on a tetherless channel, can be your cordless at home!

Cellular Network

a global network where the topological coverage is obtained with a set of adjacent or overlapping areas called *cells*. The mobile terminal (user) can move from one cell to the other keeping the communication seamlessly active



Wireless Network with a Fixed Point of Access

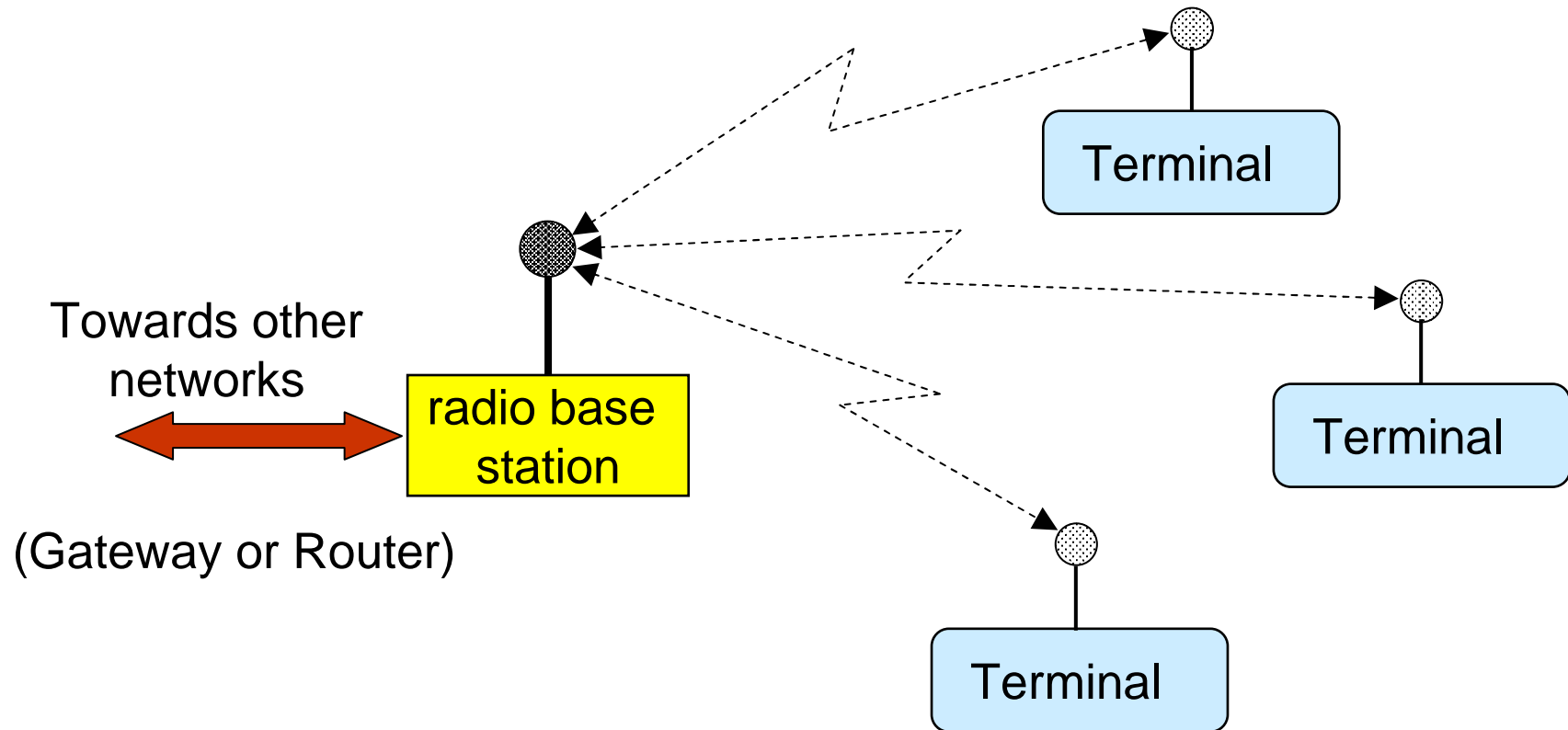

Ad-Hoc Self Configuring Wireless Network

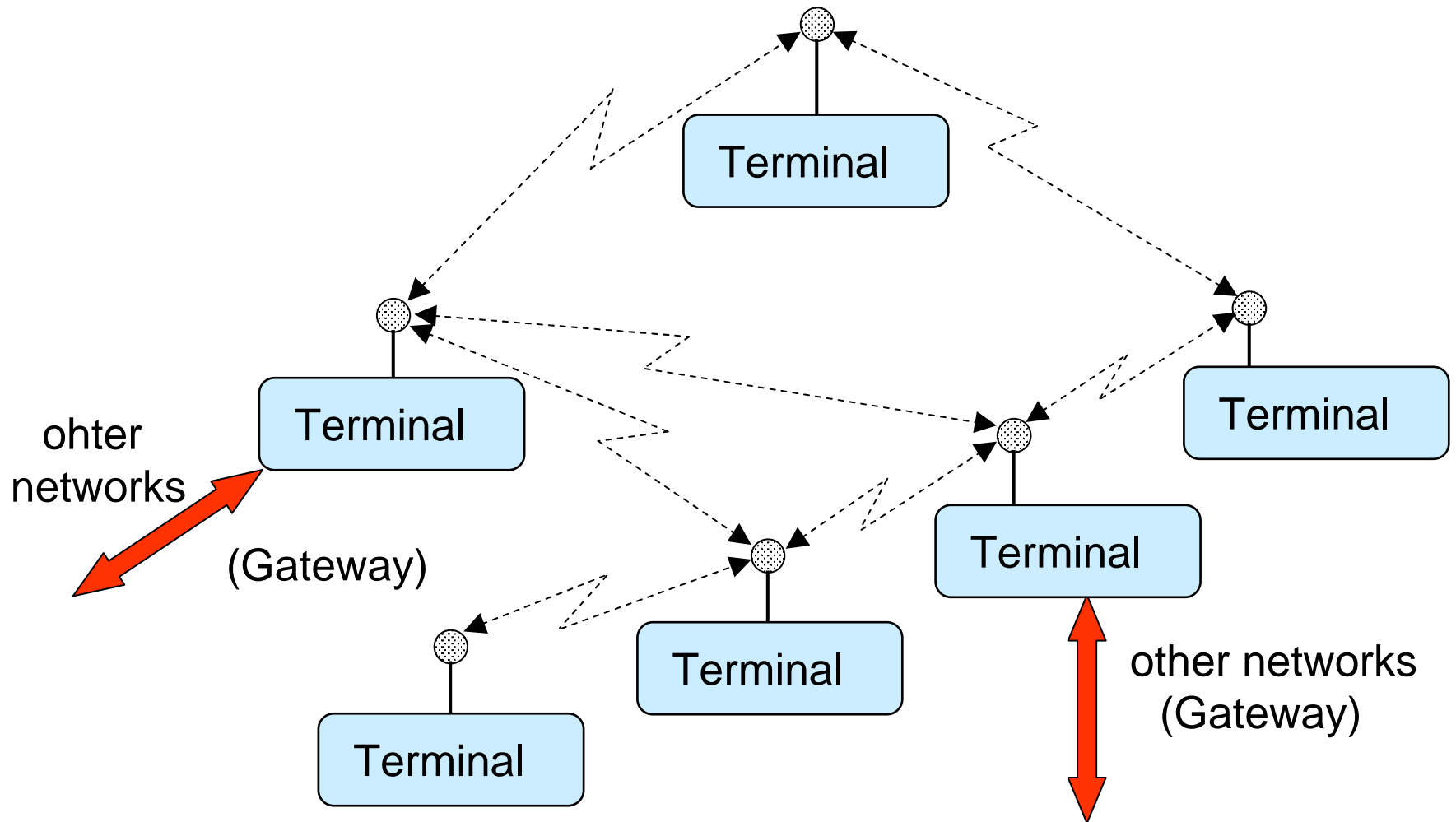

Cellular Network

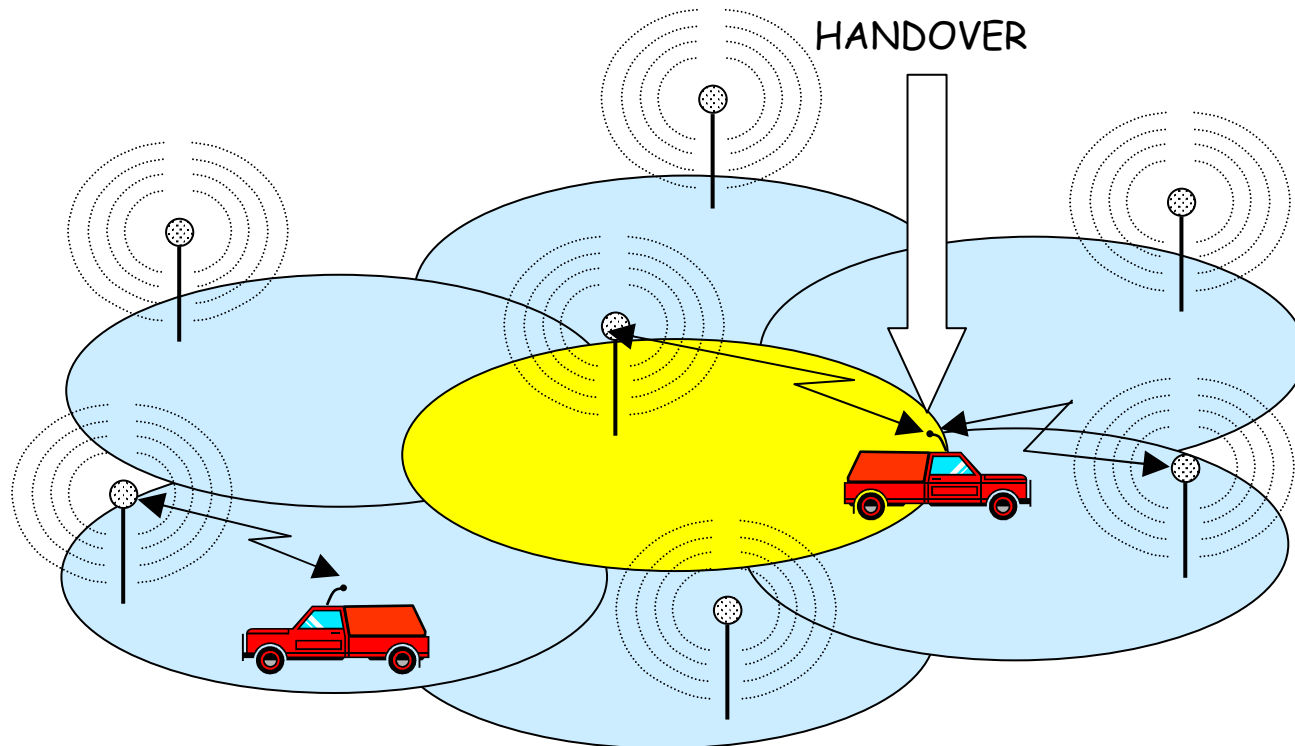

Wireless Local Access

- Nomadic communications are characterized by a first (second, third ...) wireless hop, then a connection to the global network
- Short range radio
- Normally shared medium
- Generally Best-Effort
- Need for authentication identification authorization (or not??)
- Warchalking is not sustainable (at least for HotSpots and professional support)



Access Protocol Rehearsal

what you *already know* but don't *remember*
what you *should know* but are not *aware*



Classification of LAN MAC protocols

- 3 types
 - Contention or Random Access (Aloha, CSMA/CD, Ethernet)
 - Ordered Access (Token Ring, Token Bus, FDDI)
 - Slotted with reservation (DQDB, Res-Aloha)
- Evaluation/Performance Parameters
 - Throughput (capacity and carried traffic)
 - Fairness
 - Delay (access, propagation, delivery)
 - Topology, Resilience, Network dimension, Number of Stations,



Random Access Protocols

- A node in transmit a packet
 - At line speed R
 - without coordination with others
- If more than one node transmit at the same time..... \Rightarrow collision
- Random Access (or contention based) MAC protocols specify:
 - How to randomize the initial access
 - How to recognize a collision
 - How to retransmit the packet after a collision



Slotted Aloha

- Time is divided in equal length slots
- Nodes transmit at the beginning of the slot only
- In case of collision retransmit either with probability p or after a random delay till success

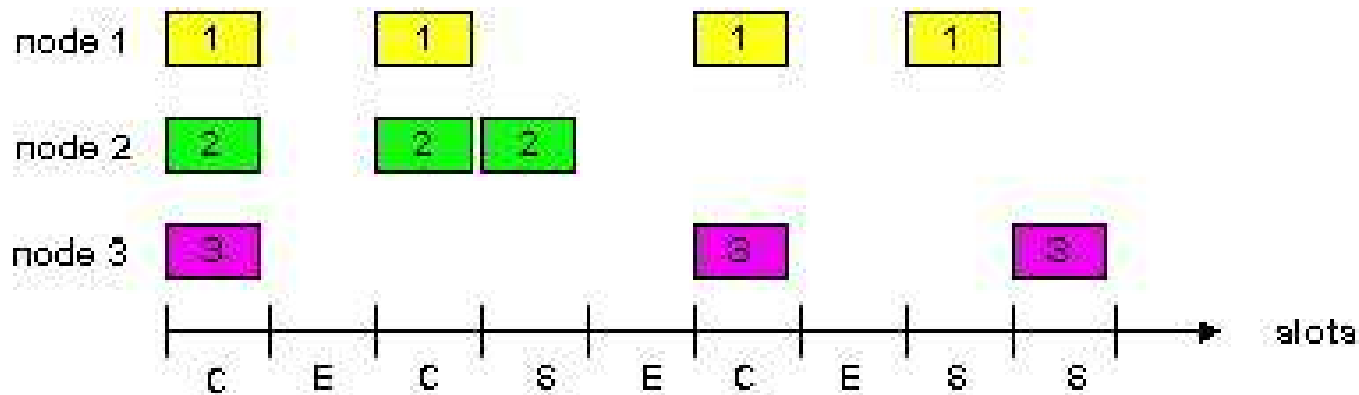

Slotted Aloha: homework

- Compute collision probability in case of Poisson Arrivals
- Compare the p-retransmission policy with the delayed retransmission one
 - are they equal? in what conditions?

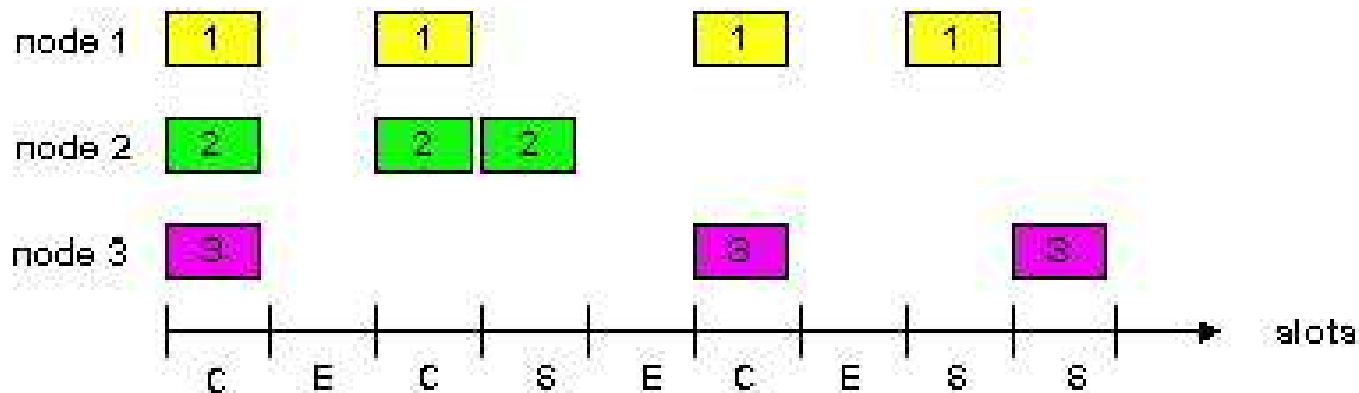

ALOHA

- Simpler, no slots no synchronization
- Transmission at any time, retransmission too, only random delay possible after collisions
- Collision probability is increased
 - yellow packet collides with other packets in $[t_0-1, t_0+1]$

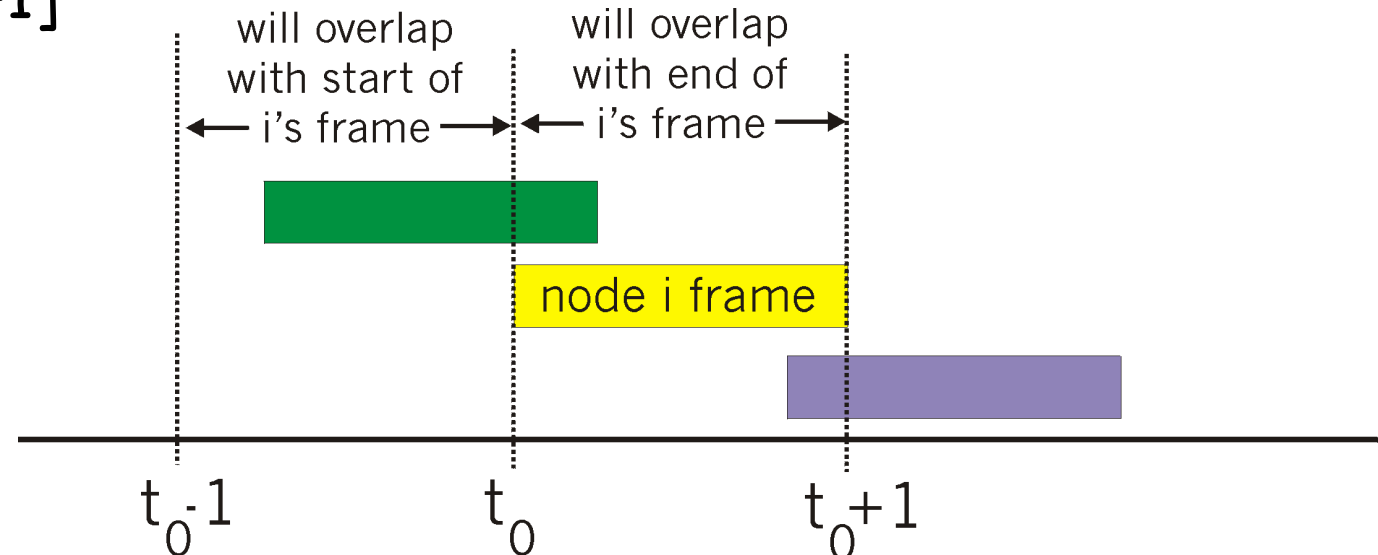

Comments

- Simple protocols
- Throughput is very limited due to collisions
 - with Poisson arrival hypotheses the maximum efficiency is
 - 18% ALOHA
 - 37% SLOTTED ALOHA
 - With other traffic may be larger/smaller
- Unstable protocols (throughput goes to zero at high loads) !!!
- At low loads access delay is close to zero
- Access delay is not guaranteed nor bounded!!



CSMA: Carrier Sense Multiple Access

- Conceived to increase throughput
- Stations listen to the channel before transmitting
 - If channel is free: Transmit Packet
 - If channel is occupied delay transmission
 - 1-persistent CSMA: Immediate transmission on free channel
 - 0-persistent CSMA: Retry after a long random delay
 - p-persistent CSMA:
 - With probability p behaves as 1-persistent
 - With probability $(1-p)$ behaves as 0-persistent



CSMA: collisions???

- May happen due to propagation delay
- Transmission time is entirely wasted
- Distance between stations plays a fundamental role in the collision probability

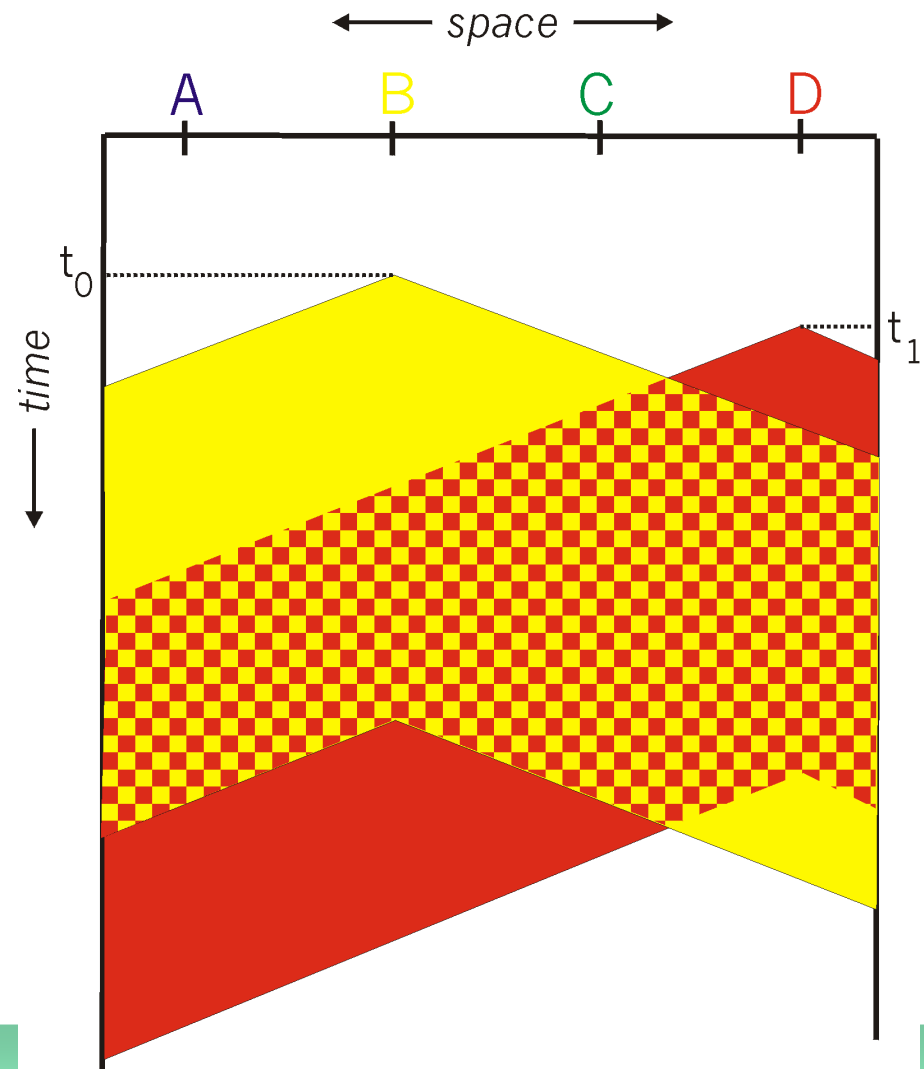

CSMA/CD (Collision Detection)

- CSMA/CD Builds on top of CSMA
 - Try to understand when a collision occurs and stop transmission
 - Wasted time is reduced
- Collision detection:
 - Easy on wired LANs: Simple power measurement with threshold comparison between transmitted and received power
 - Practically impossible in WLANs
 - Half Duplex
 - Power fluctuation/Power attenuation



CSMA/CD collision detection

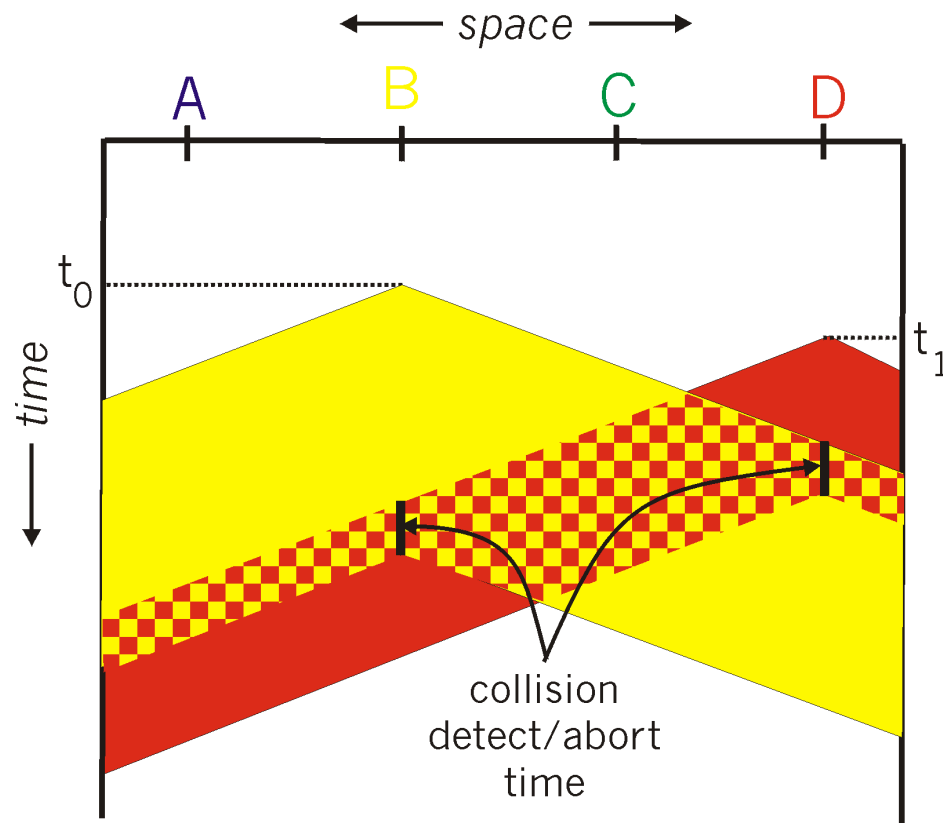

CSMA/CD: Performances

- The fundamental parameter is end to end propagation delay
 - More precisely what counts is the ration between the (average) packet transmission time and the e-t-e propagation delay
- Performances are optimal for small, slow (in terms of transmission speed) LANs with large packet dimension
- There is a minimum packet size required to identify collisions



CSMA/CD: Performances

- The 1-persistent behavior is normally preferred for the low access delay at low loads
- The protocol is instable, just like any contention based protocol without "corrections"
 - Exponential backoff on transmissions to induce stability
 - Dimension and No. of stations limits adapted to backoff
- It's not easy to introduce traffic differentiation and priority
- **This is Ethernet !!**



Protocols and Architectures

understand the "world" we're moving in

Architecture & Protocols

- ITU-T & ISO definition:
 - **Communication**: information transfer following predefined conventions
- Communication require cooperation
- An abstract description of communication among two or more users requires a **reference model**
- The highest level abstraction of a reference model defines a **network architecture**



Network (Protocol) Architecture

- A network architecture defines the *objects* and *entities* used to describe:
 - The communication process
 - Relationships among these objects/entities
 - Functions required for communication
 - Organization modes of these functions
- Modern communication architectures are layered
 - Easier design
 - Easier management
 - Easier standardization and greater modularity
 - Function separation



Function separation: Internet

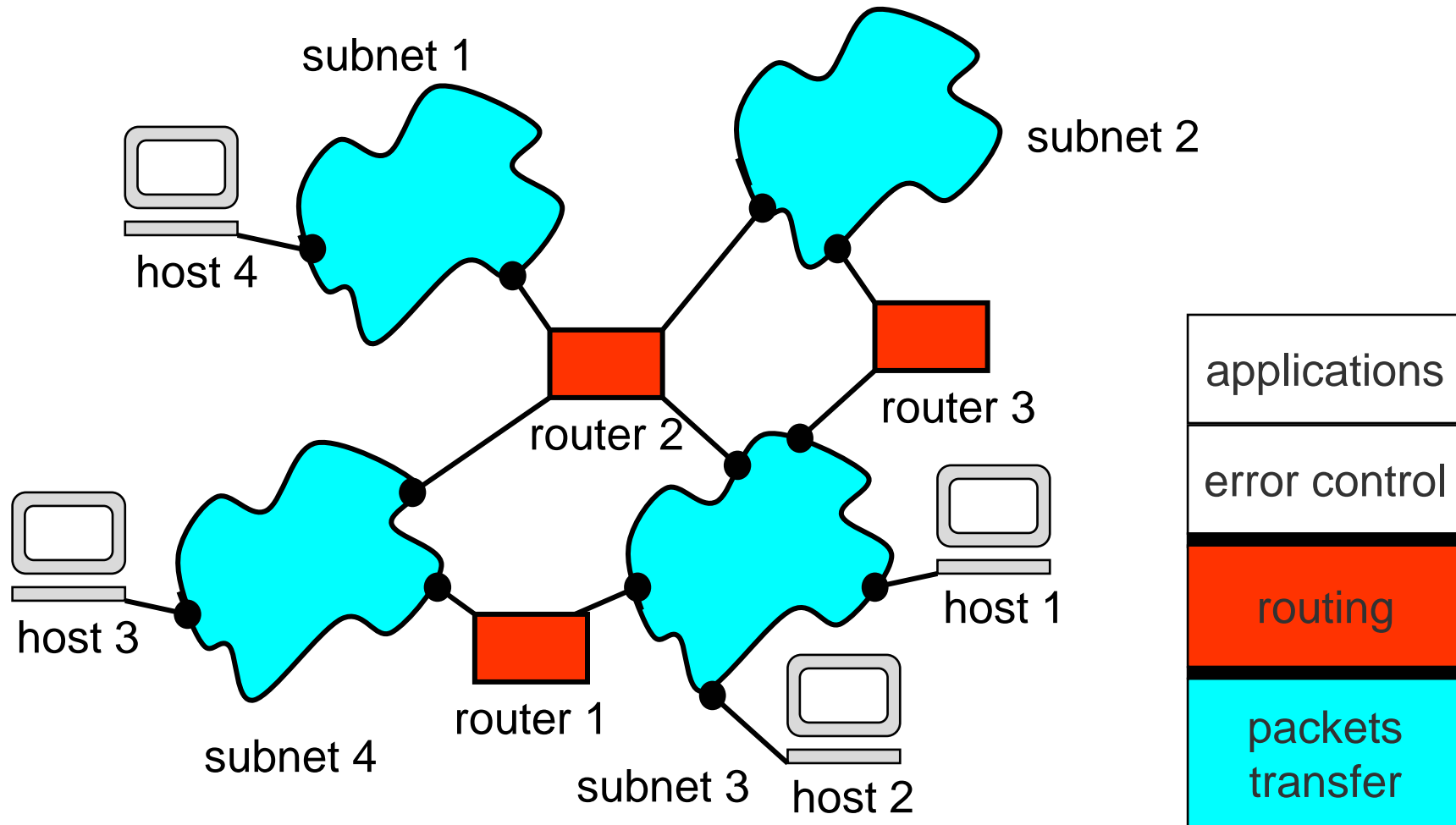

Protocols

- ITU-T & ISO definition (once again!)
 - formal description of the procedures adopted to ensure communication among two or more objects at the same hierarchical level
- Protocol definition (design):
 - **Semantic**
 - The ensemble of commands and responses
 - **Syntax**
 - The structure of commands and responses
 - **Timing**
 - Temporal sequences of commands and responses (procedures)



Protocols

- In other words:
 - Semantics
 - Algorithms
 - Syntax
 - Formats
 - Timing
 - State machines and sequential diagrams



ISO/OSI reference model

- (Open System Interconnection) is today the basis (sometimes disregarded for ignorance and sometimes questioned for philosophy) for any protocol design, from the physical layer to the application layer ... to overlay structures such as web-services and peer-to-peer systems
- We are talking about **principles**, not the detailed functionalities and not even the detailed layers, objects, entities



OSI Reference Model

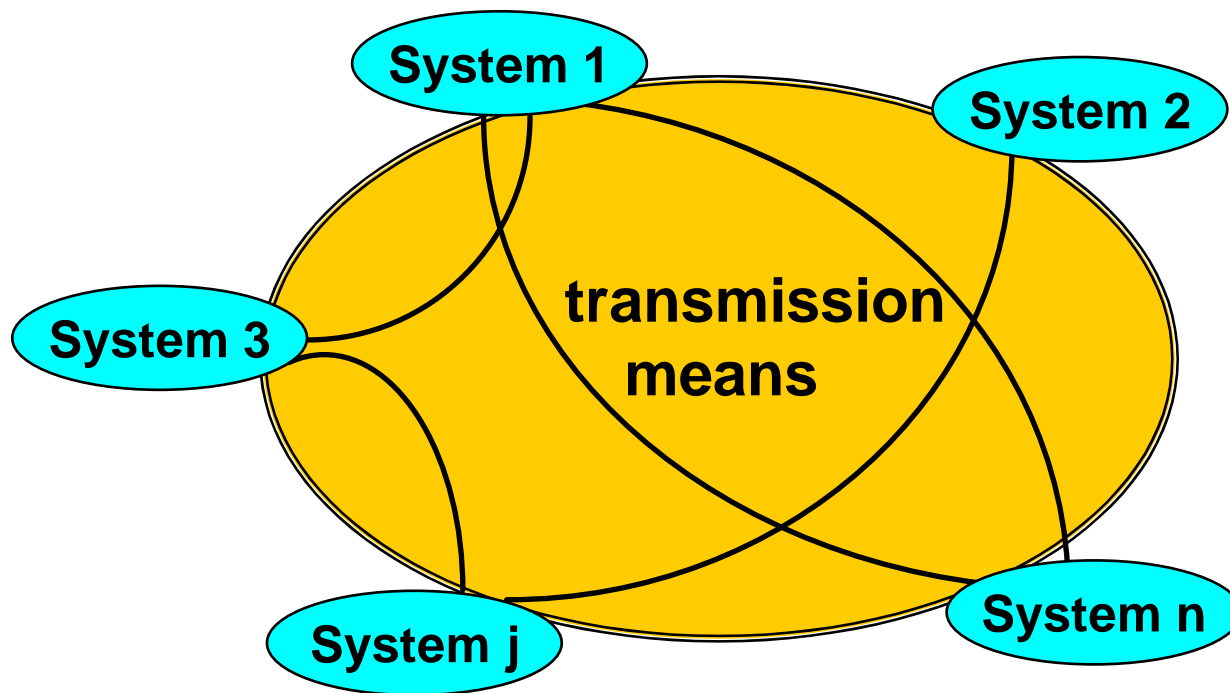

OSI Reference Model

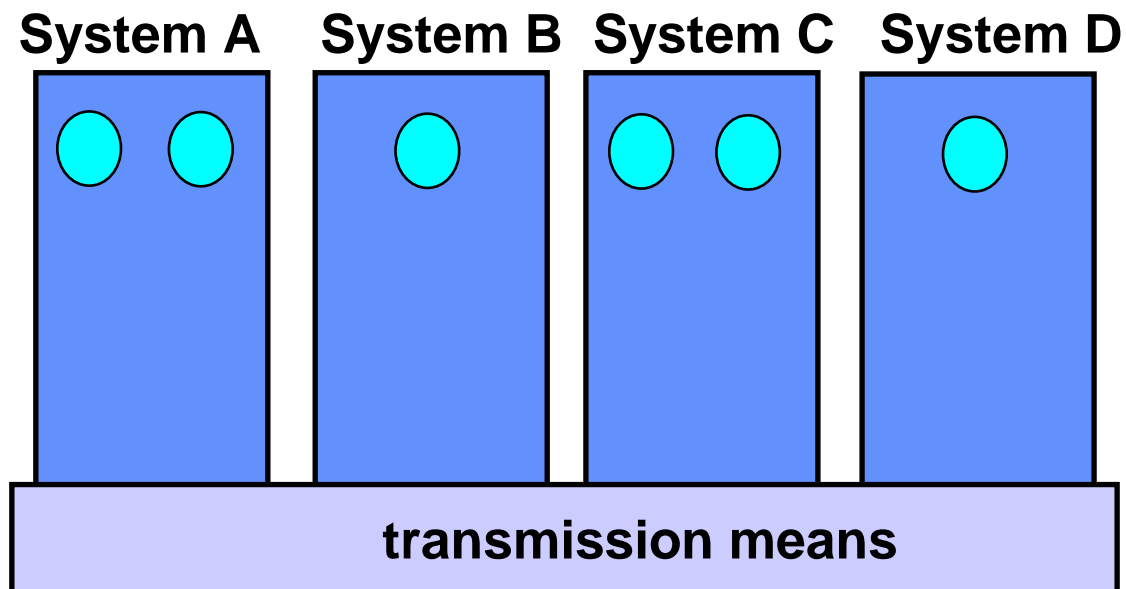

● application processes



Layers

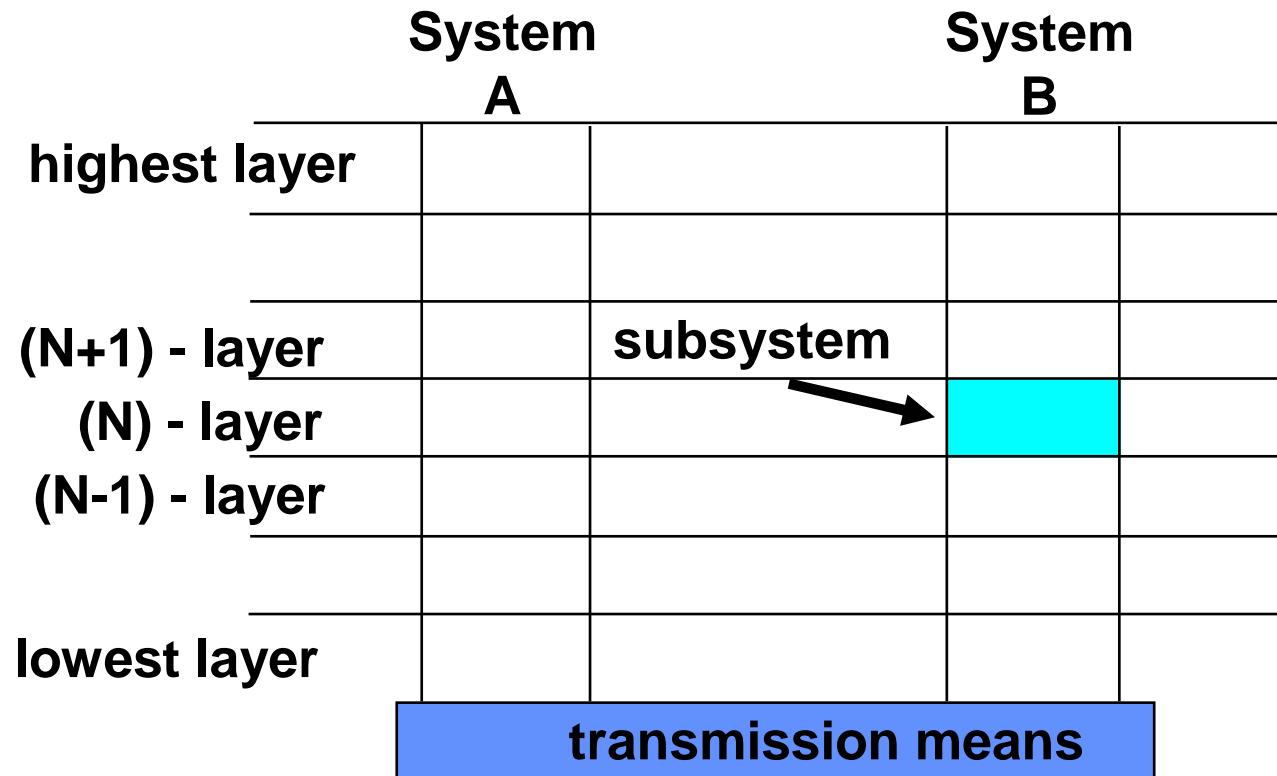

Entities

- Active elements in a sub-systems
- Fulfill layer operations
- Interact with peer entities

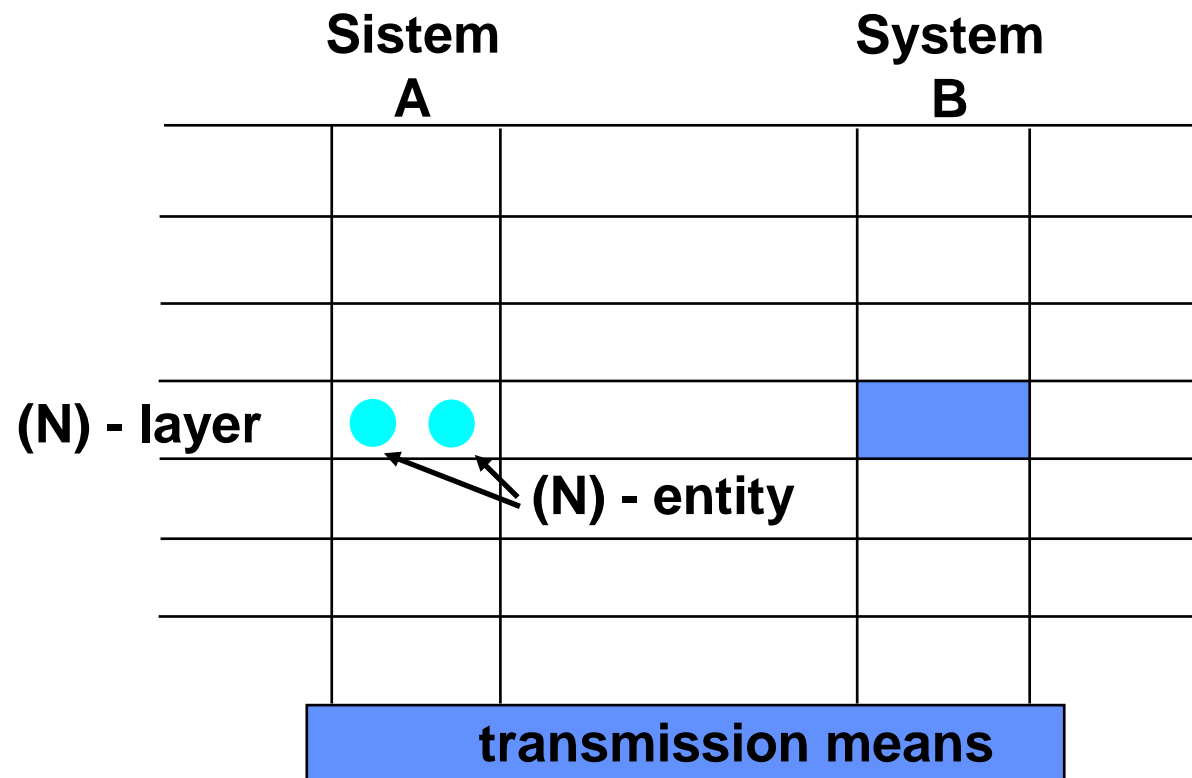

Layering

- Each Layer (N)
 - Provides services to the upper layer (N+1)
 - using
 - (N-1) Services
 - Own functions
- Identify:
 - service providers
 - service users
 - SAP (Service Access Points)



Services

- N-layer users -(N+1) - entities- cooperate and communicate using the (N)-service provided by the (N)-service provider

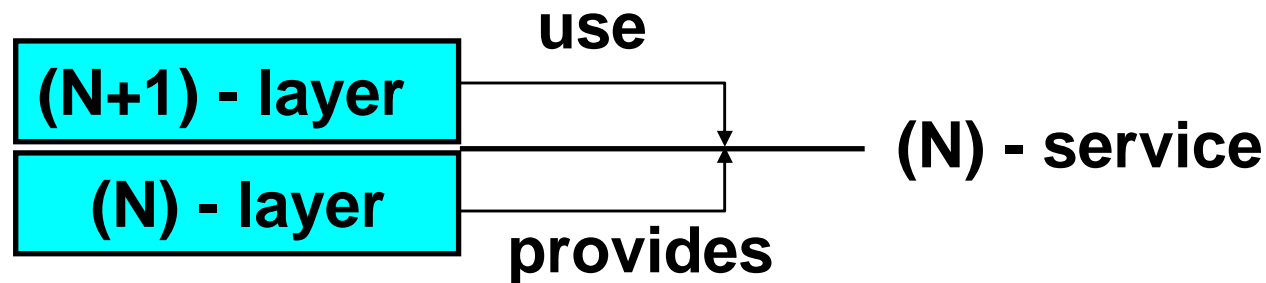

- In TCP/IP this are the "socket" between application layer protocols and TCP/UDP



Services

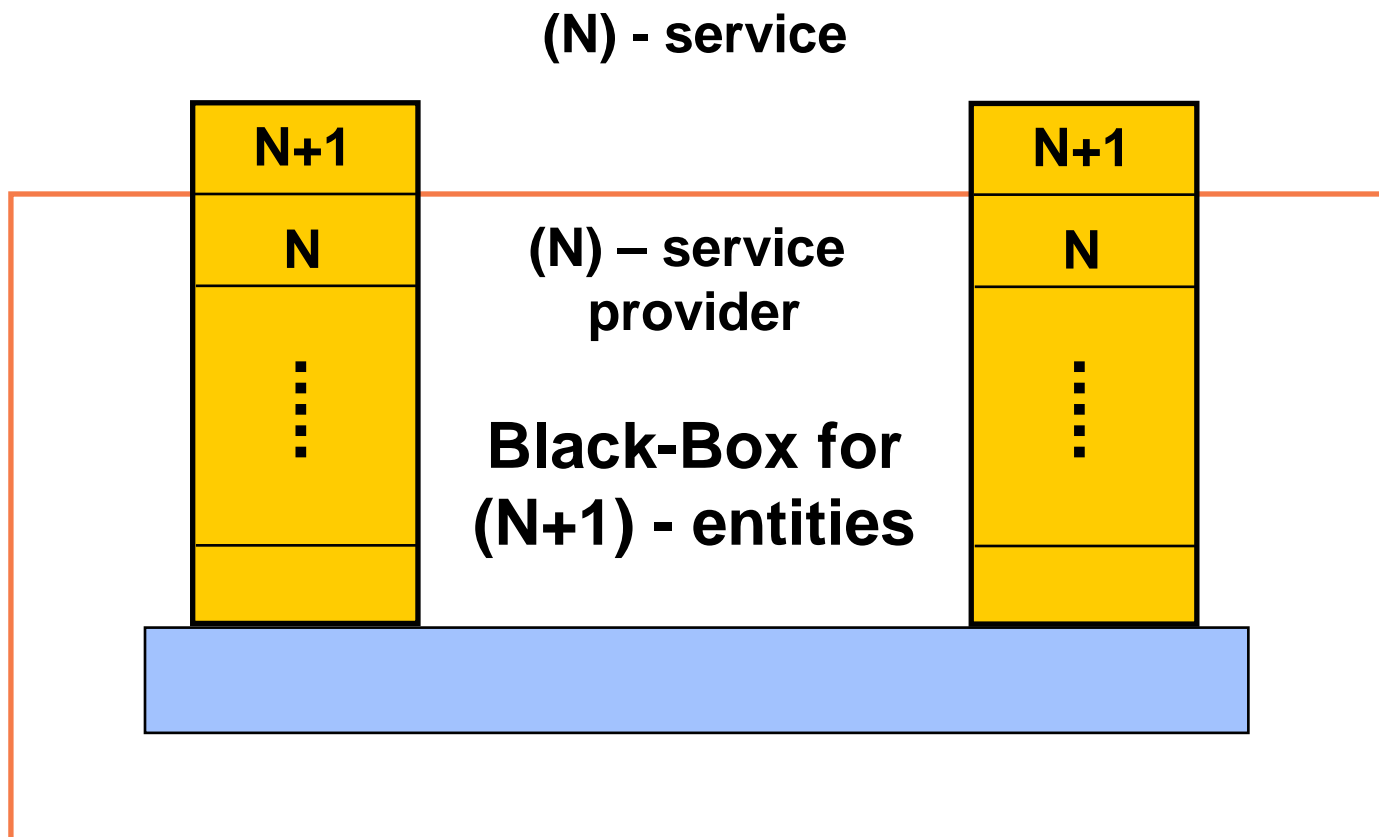

SAPs

(N) - layer

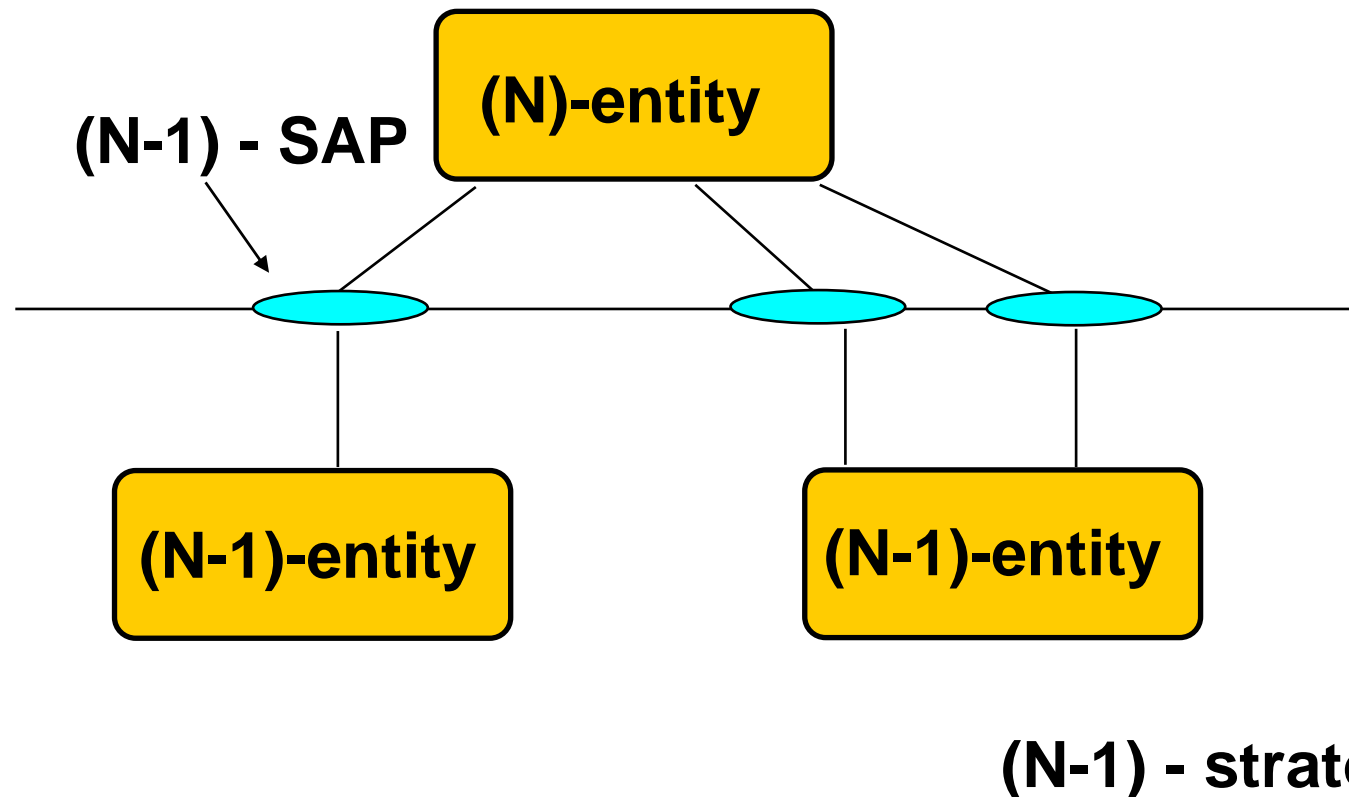

In Internet we have many different names for SAPs, from sockets to buffer to simply c-functions non formally named (e.g., the "ethernet" interface of Linux kernels)



Protocols

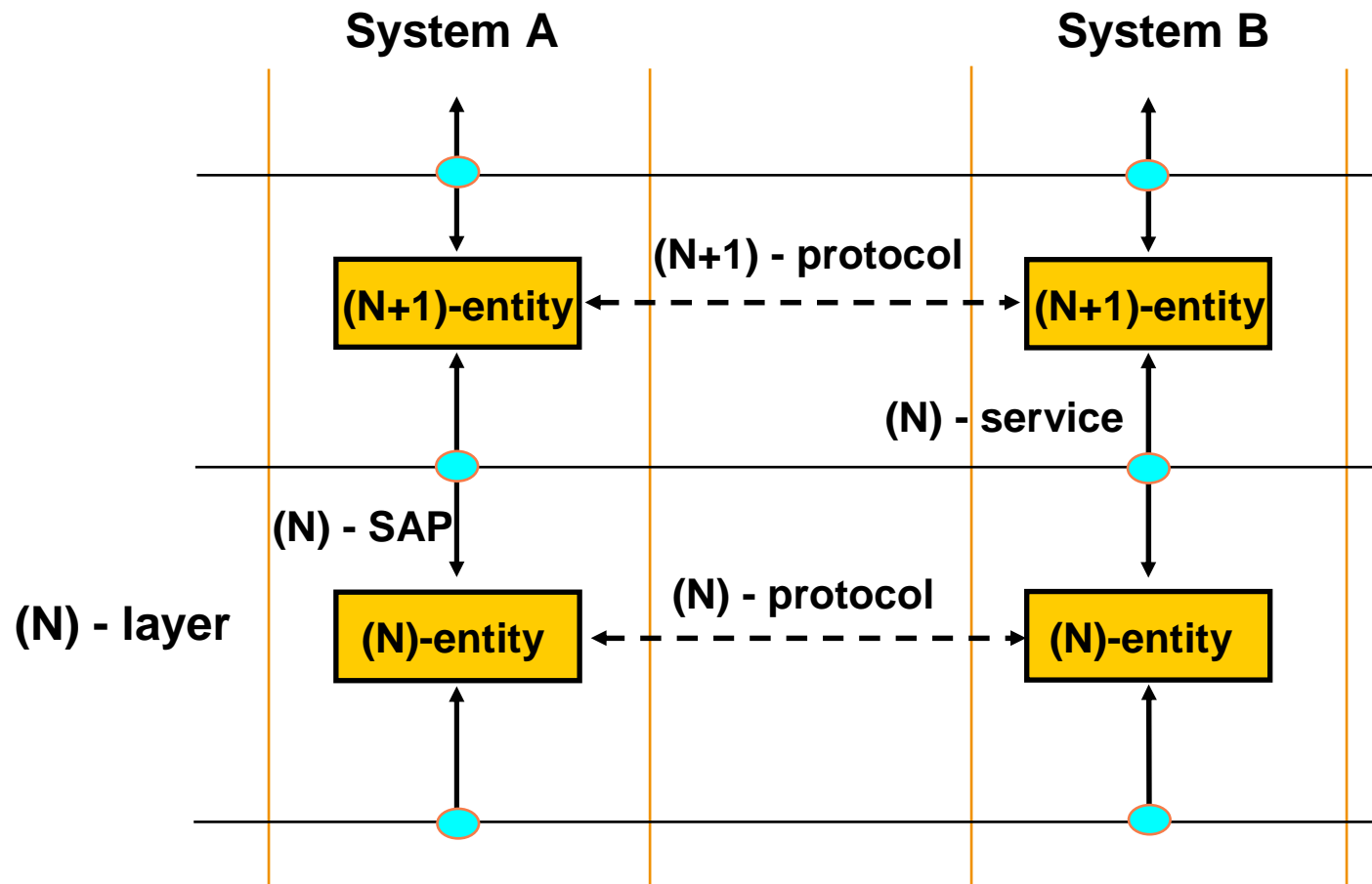

Indirizzi

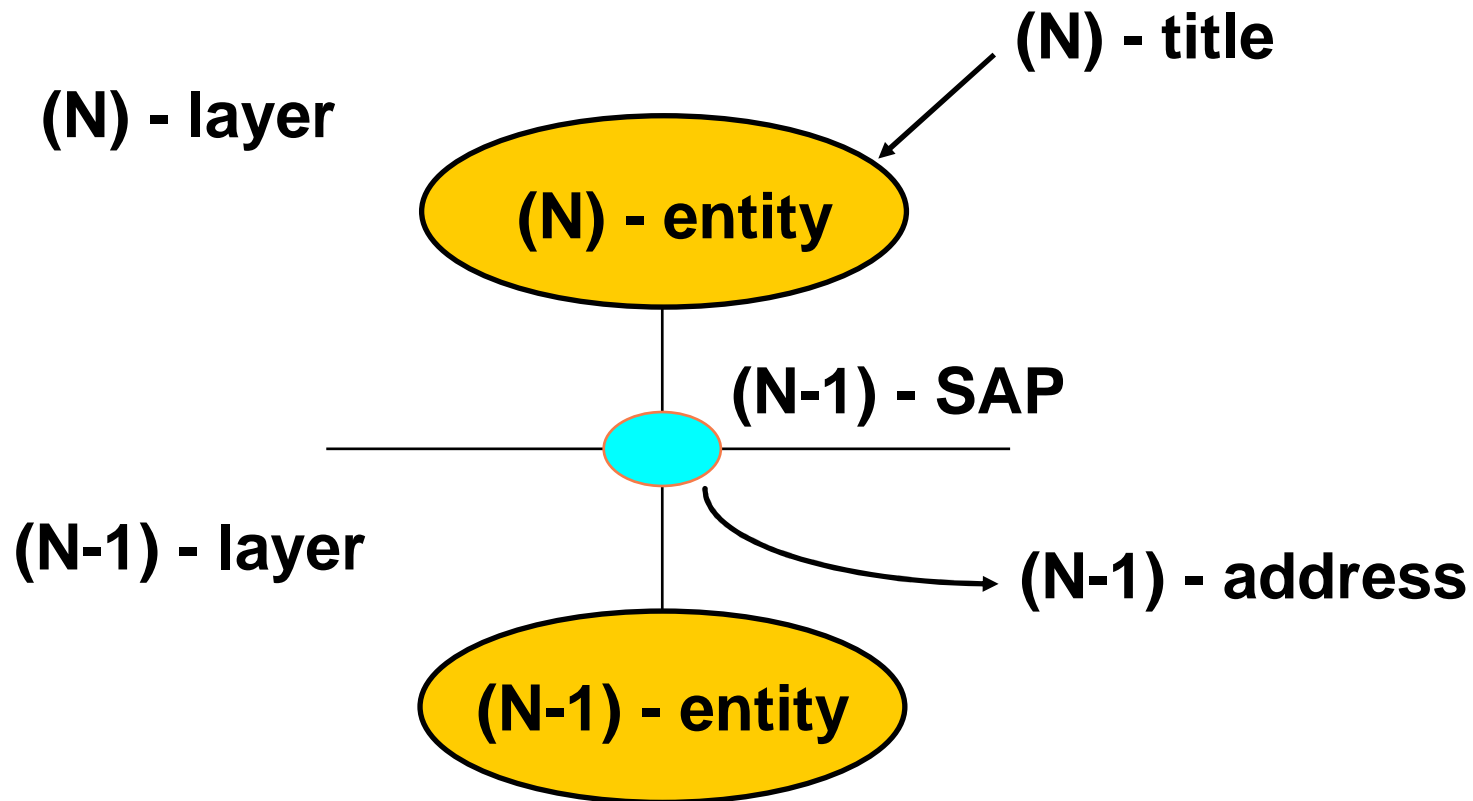

In TCP/IP addresses are named "port", "protocol", depending on the layers.

Notice the differences/similarities with IP-addresses



Mapping Types

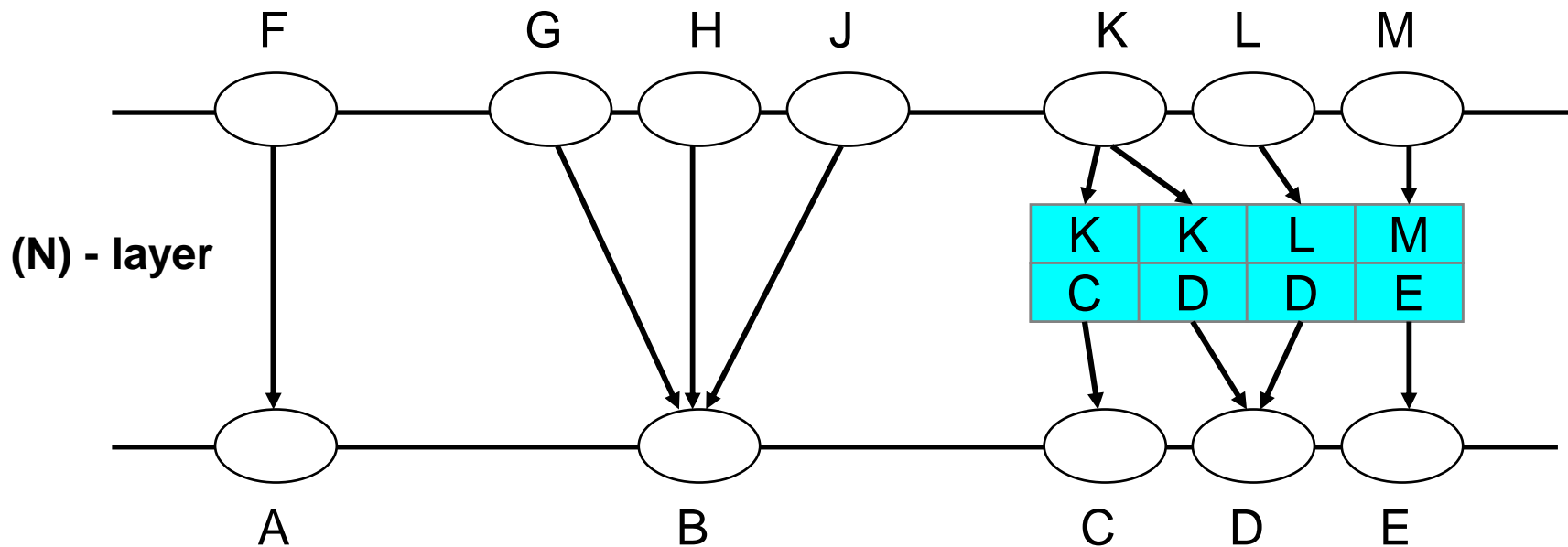

one-to-one hierarchical

tabular



Connections

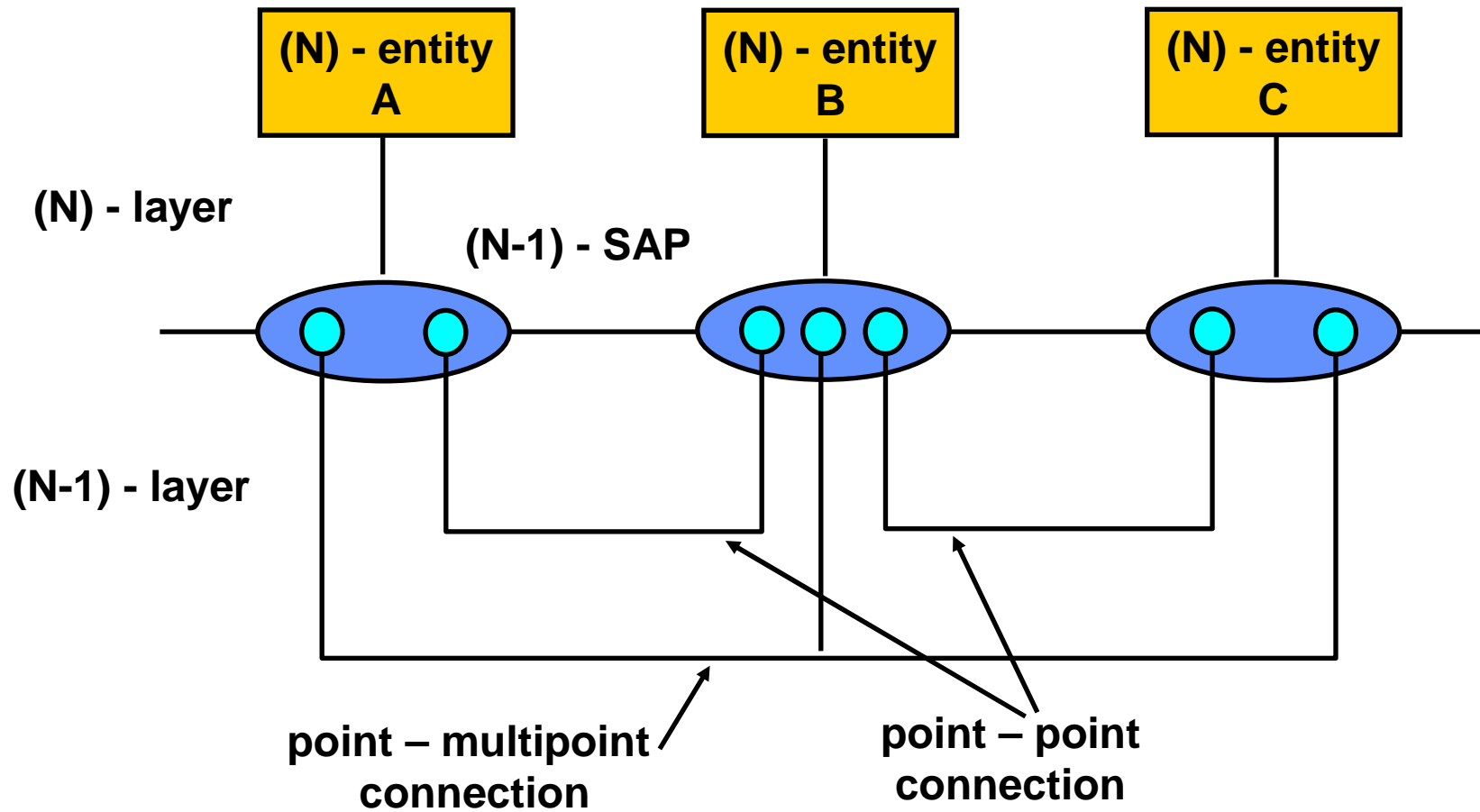

Agreements

**Three parts agreement:
connection oriented communications**

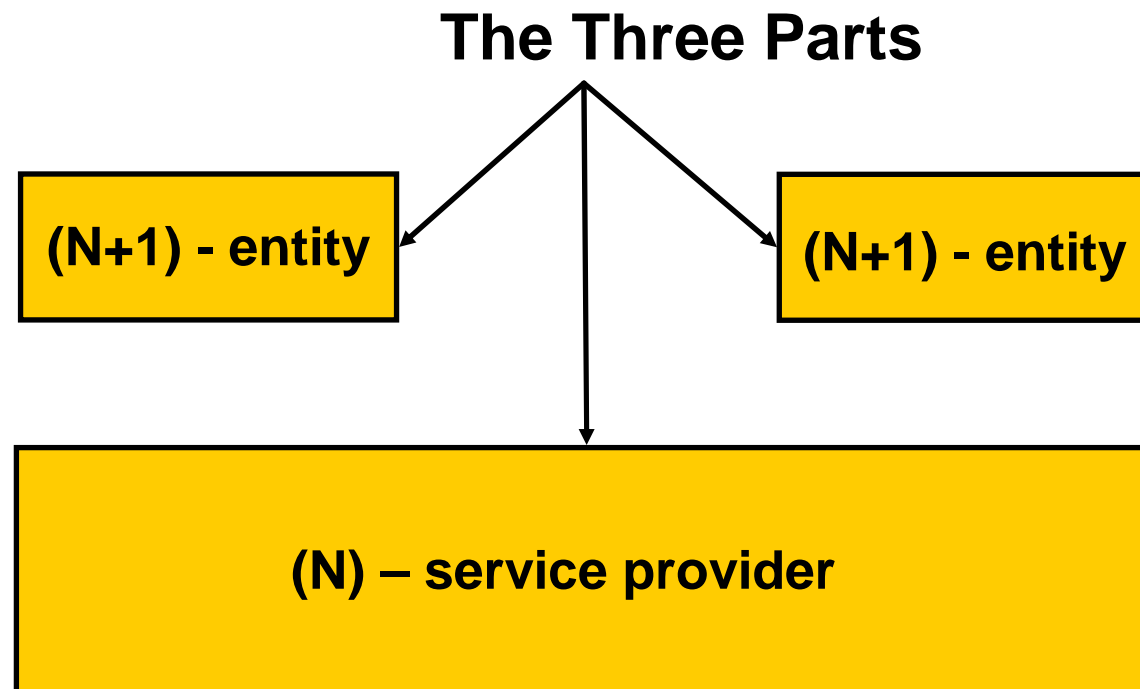

Agreements

**Two parts agreement:
connectionless communications**

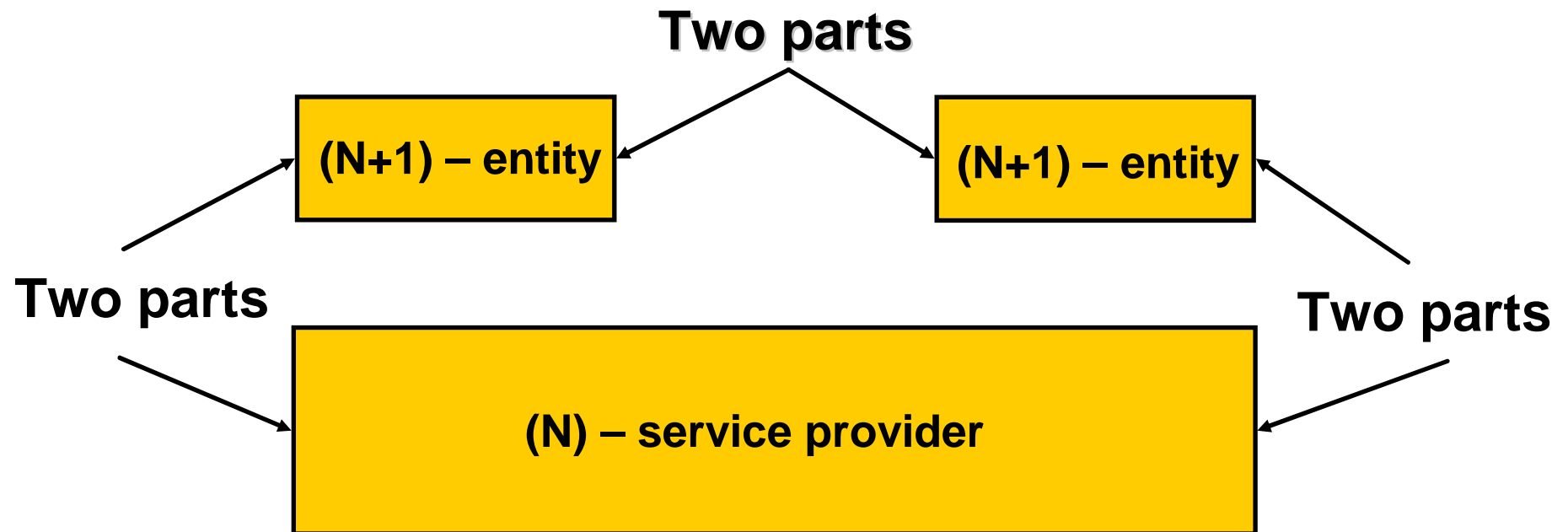

Connections

- Multiplexing (N) - connections onto a (N-1) - connection

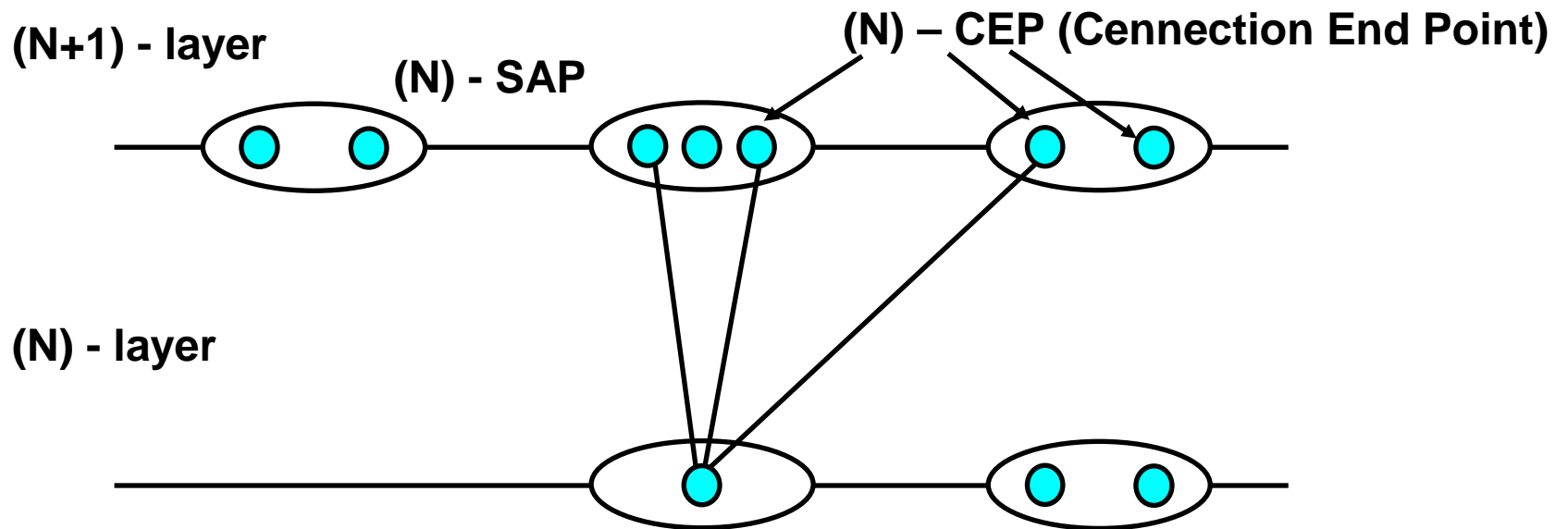

Connections

- (N) - connection splitting onto multiple (N-1) - connections

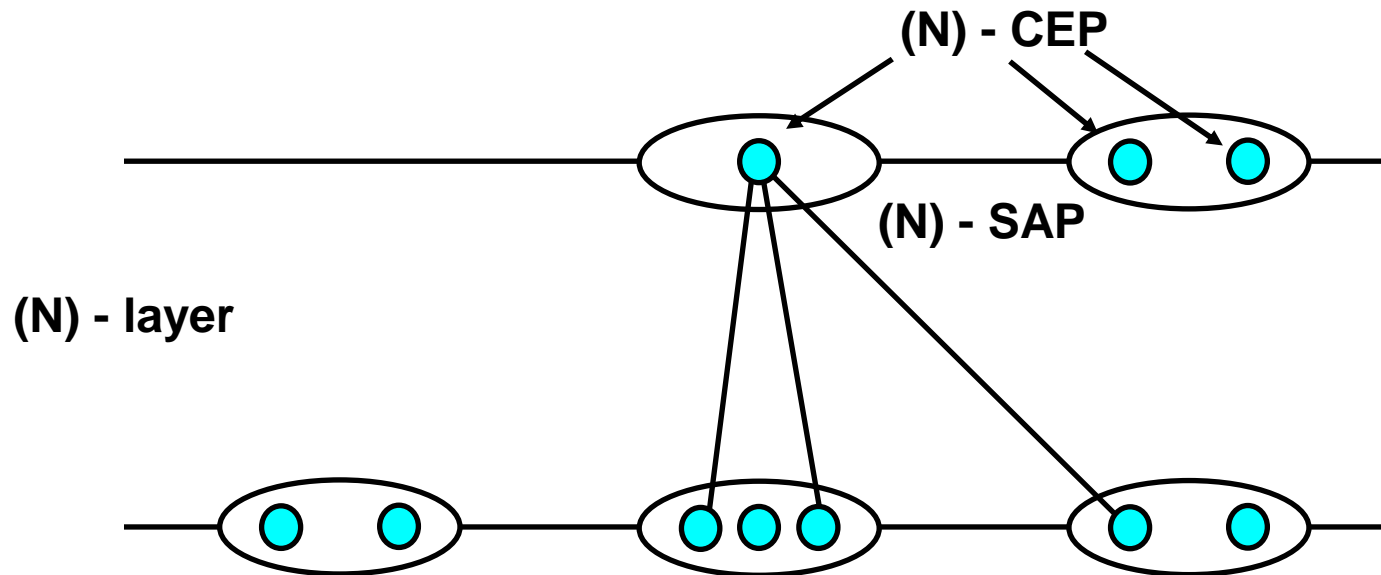

PDU Formation

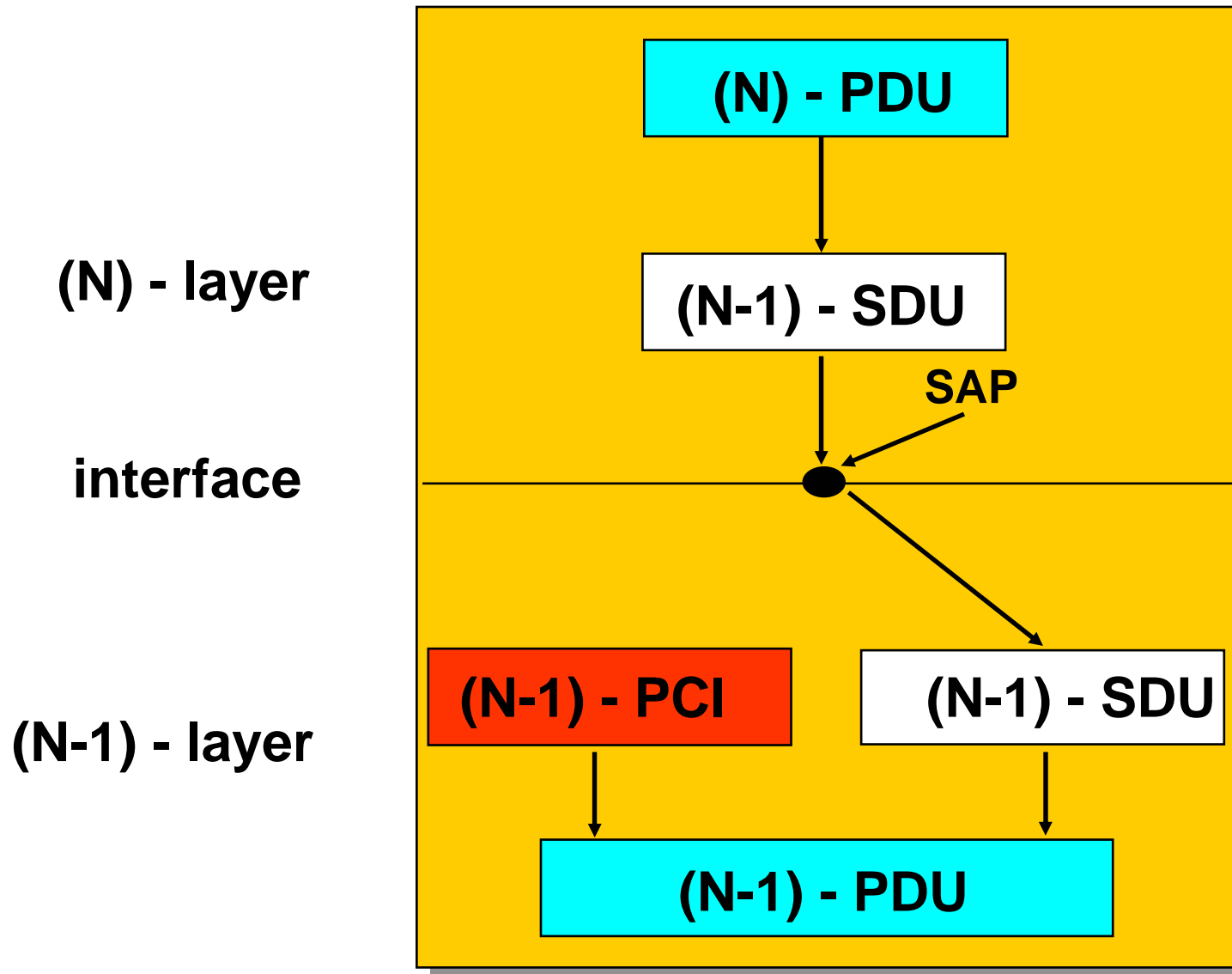

PDU Formation

- Data Units can be
 - segmented
 - concatenated
- Segmentation may follow two “paths”
 - Building more (N) - PDUs from one (N) - SDU
 - Generating more (N-1) - SDUs from one (N) - PDU
- Similarly for concatenation

- Often both processes are called segmentation for the sake of brevity



Information Transfer

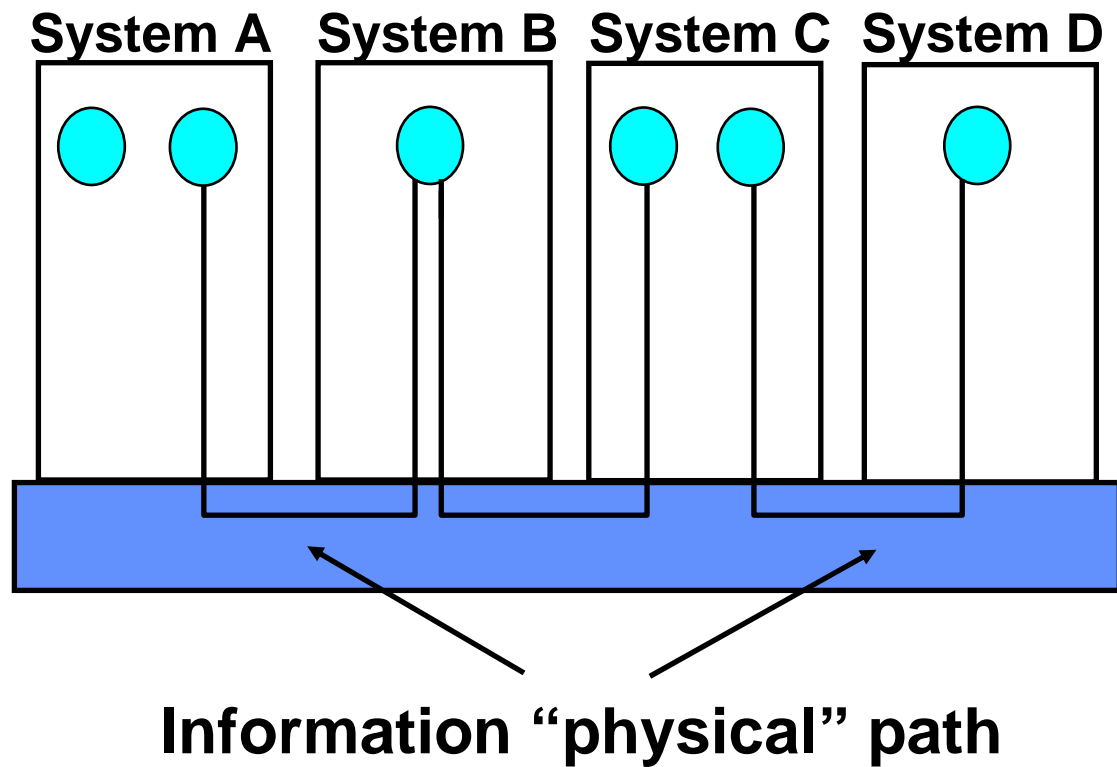

Primitives

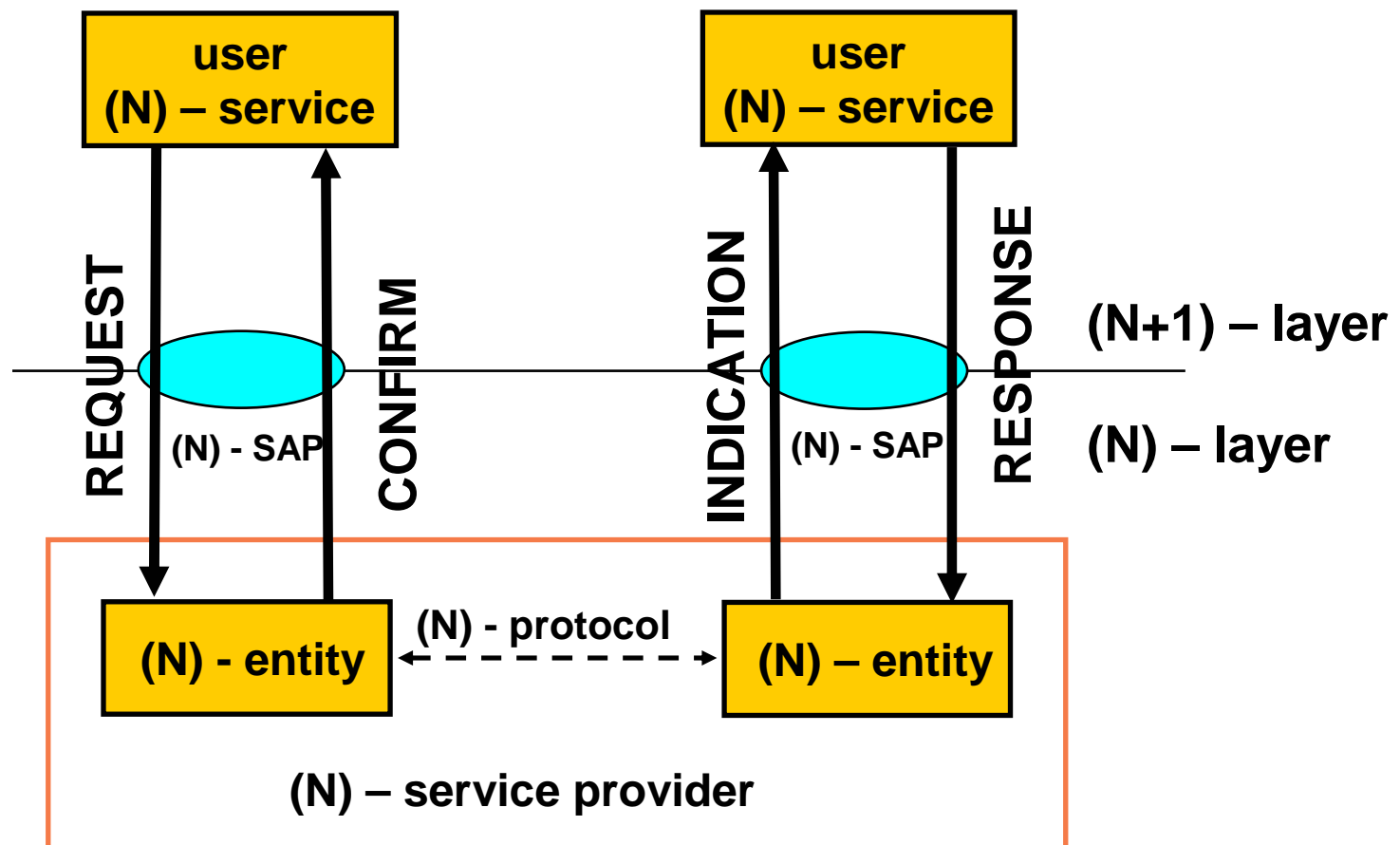

Primitives' Use

Confirmed Service

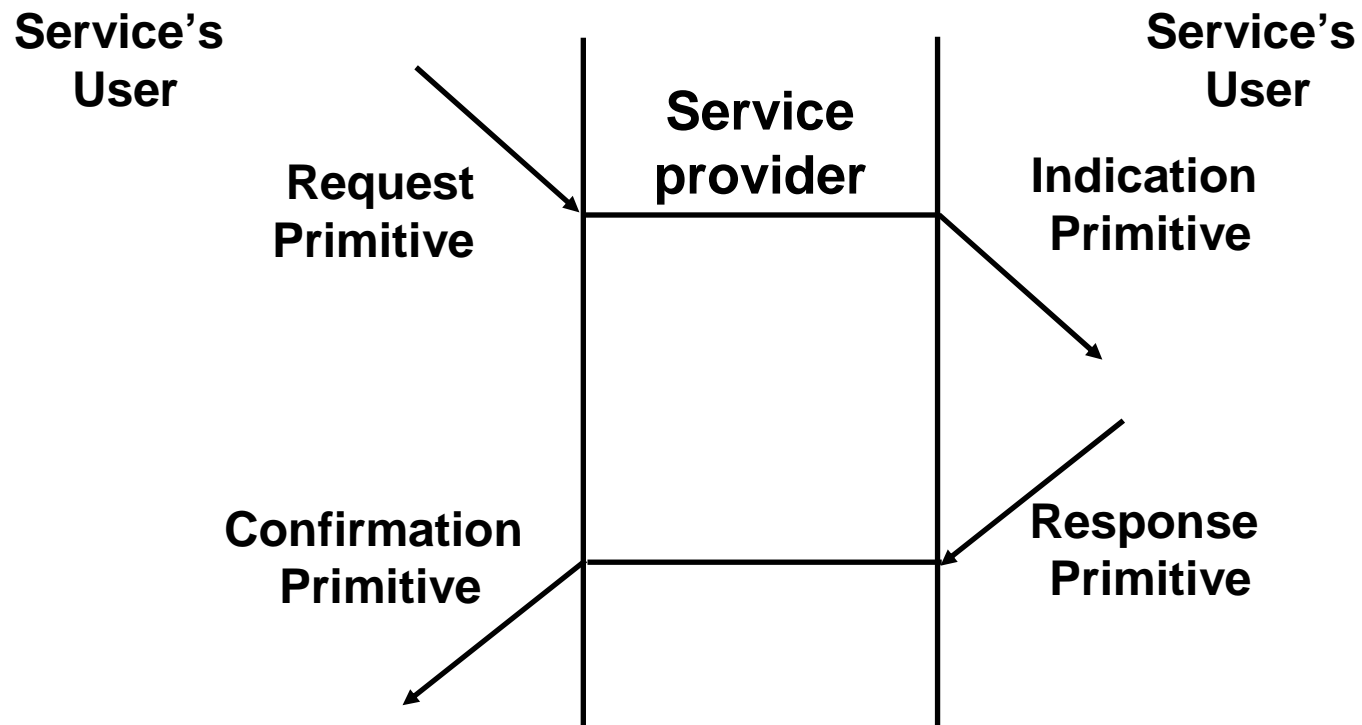

Primitives' Use

Un-Confirmed Service

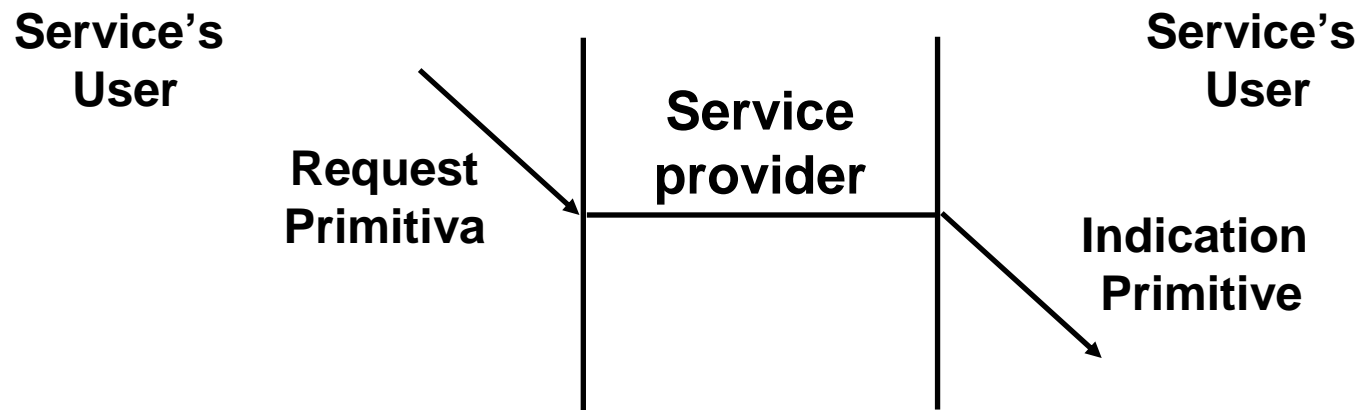

Primitives' Use

Service Provider Initiated

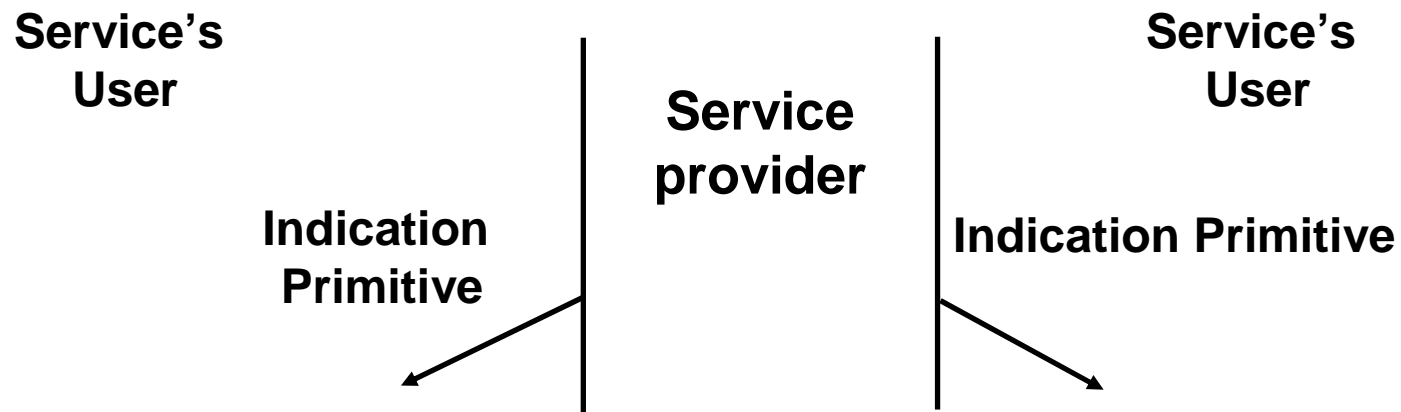

Nomadic Communications & WLANs

characterized by LAN-like wireless access
typically use Internet upper layers
requires some means to handle portability and
(sometimes) local mobility

LAN Protocols

- Standardization process started in the '80s by IEEE 802 project:
 - ▣ 802.1: *LAN Internetworking*
 - ▣ 802.2: *LLC Sublayer*
 - ▣ 802.3: *CSMA/CD: Ethernet* is a small (1-bit in the header) variation of 802.3
 - ▣ 802.4: *Token Bus*
 - ▣ 802.5: *Token Ring*
 - ▣ 802.6: *DQDB (for MANs)*



LAN Protocols

- Work is still going on in many technical committees and new committees are founded every year (or close to):
 - ▮ 802.7: Broadband Technical Advisory Group
 - ▮ 802.8: Fiber-Optic Technical Advisory Group
 - ▮ 802.9: Integrated Data and Voice Networks
 - ▮ 802.10: Network Security
 - ▮ **802.11: Wireless Networks (/a/b/g/h/f/s/n/p/...)**
 - ▮ 802.12: 100base VG
 - ▮ 802.13: 100base X
 - ▮ **802.15: Personal Area Networks (.1 [Bluetooth]4 (ZigBee))**
 - ▮ **802.16: Wireless MAN (WiMax & Co.)**
 - ▮ ...

